

TECHNICAL DATASHEET



EF TAPPING SADDLE

04 Update - 05/2024

TECHNICAL DATA

Article No	001 117 2071 0327
d (mm)	315
d1 (mm)	63
le (mm)	105
h (mm)	336
h1 (mm)	191
Z (mm)	164
L (mm)	160
Weight (Kg)	1,370
Box Quantity (pcs)	4
Box Dimension (cm)	36x60x46,5

INJECTION MOULDED

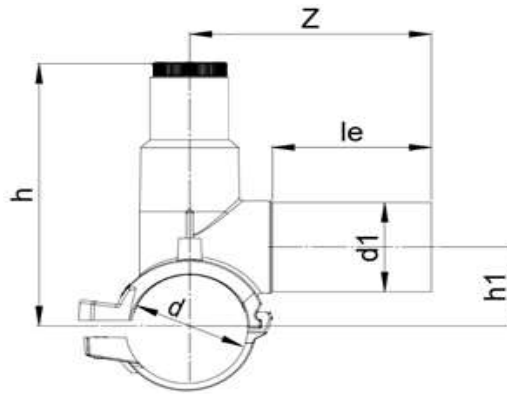

IDENTIFICATION OF PRODUCT

D(mm)	315-63
SDR	11
RAW MATERIAL	PE 100
PRESSURE CLASS	16 Bar Water 10 Bar Gas
TRADEMARK	NTG
EXECUTION	Injection Moulded
STANDARD	EN 12201-3 EN 1555-3 AS / NZS 4129

SPECIFICATION	Suitable for SDR11....17 pipe Injected monobloc type 4 mm pin connectors Long Fusion outlet Hexagon wrench 12 mm O-ring sealed screw cap
---------------	---

EF SPECIFICATION

WELDING VOLTAGE	40 V
RESISTANCE	7,0 Ω
WELDING TIME	130 Sec.
COOLING TIME	15 Min.
WINDING TYPE	Monofilar

WELDING BARCODE



142007323153407005130113

Tolerance on diameters and thickness according to the standards. The other dimensions are specialized. Tolerance $\pm 5\%$. NTG PLASTIK reserves all the right to change any information without giving prior notice. The production, distribution and utilization of this document without explicit authorization is prohibited.